

# VACTOR<sup>®</sup>

Subsidiary of Federal Signal Corporation

## COLORING BOOK

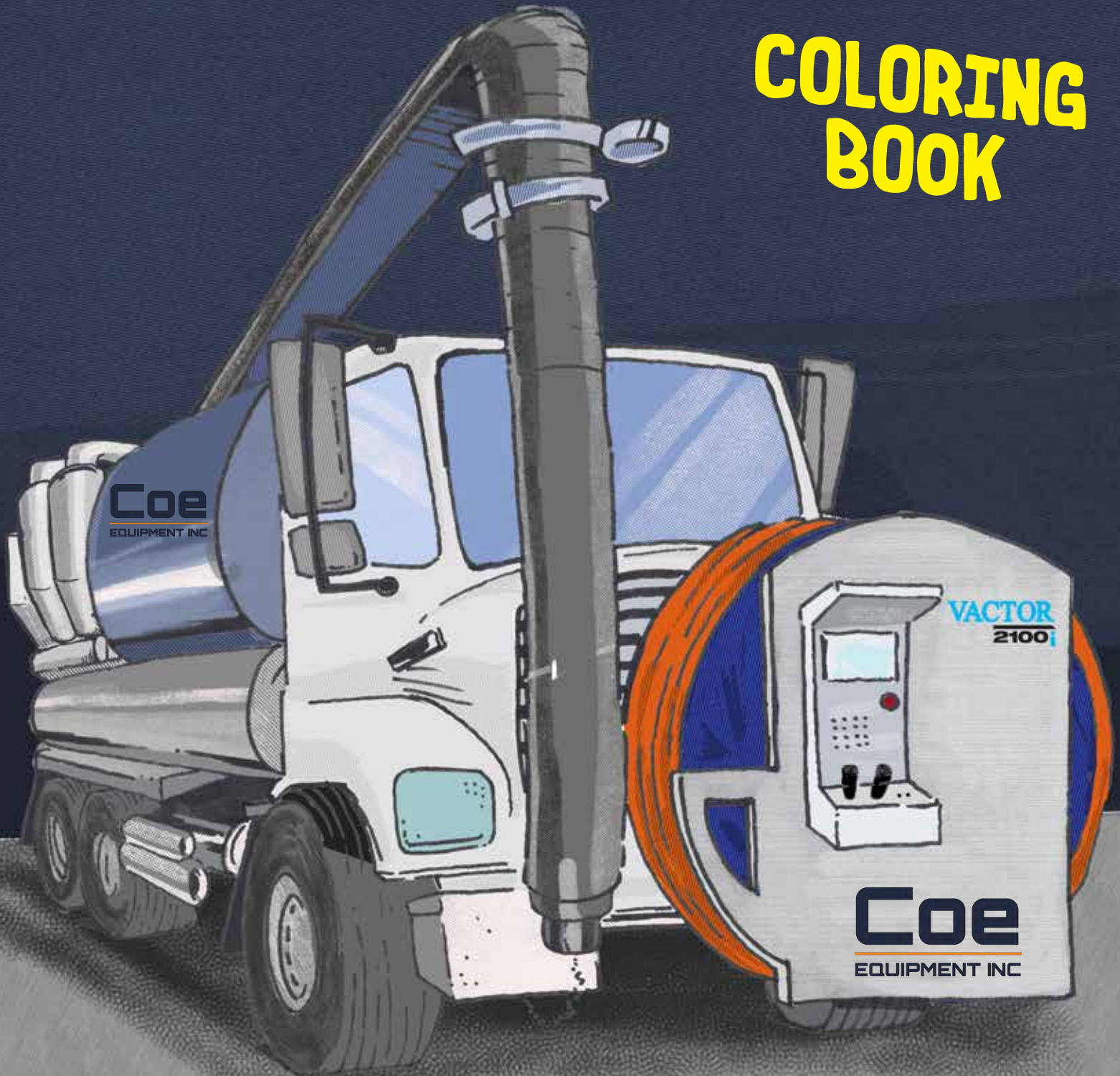

**Coe**  
EQUIPMENT INC

**VACTOR**  
2100

**Coe**  
EQUIPMENT INC

**COE**  
EQUIPMENT INC

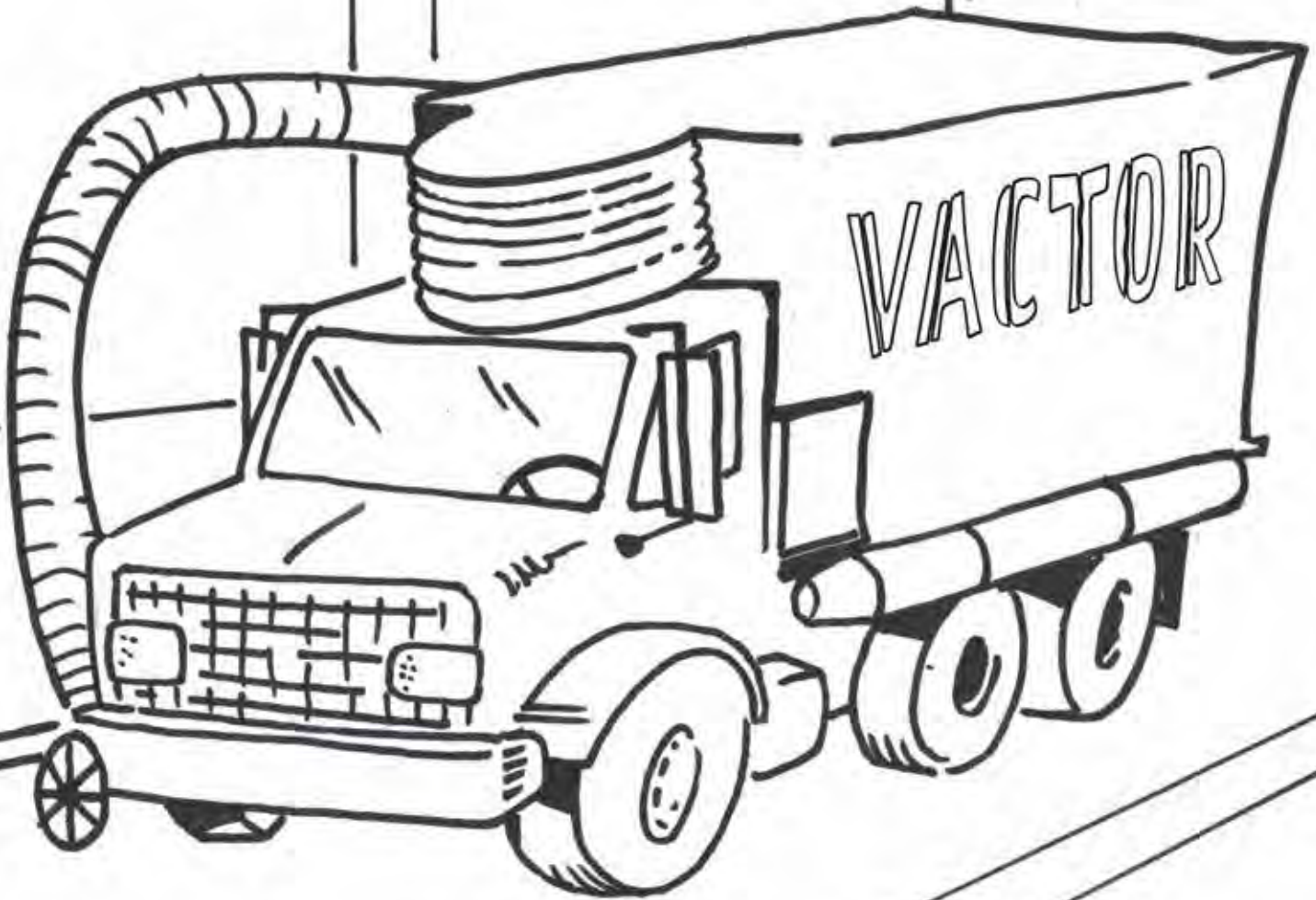

**100+ YEARS OF  
SOLUTIONS**



**Coe**  
EQUIPMENT INC

# WATER LIFECYCLE



# HELPING TOWNS & CITIES

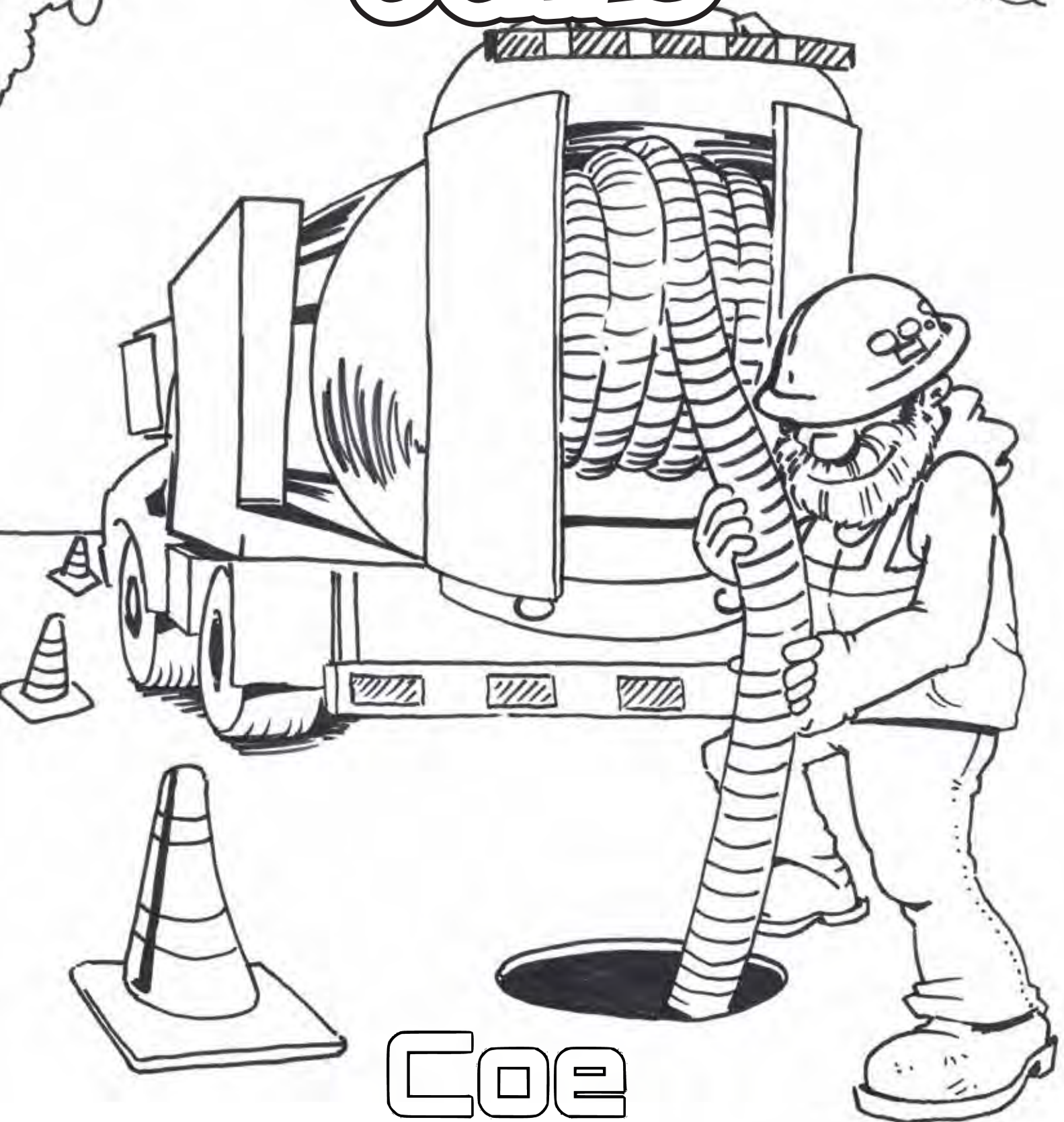

**Coe**  
EQUIPMENT INC

# WORD SEARCH

**COE**  
EQUIPMENT INC

D T D L V P G V G L Y Z J L N O E C Y S  
W S N C W B L N K T C A B L A V V A R T  
R D L E P I I J E O U U C F U M I T E R  
E E E S G N R F Z E S Z B K Y E T C W E  
C E T M I I A E V I T I U T N I A H E A  
N N E A K S L Y L Q H P Z K W G V B S T  
A K R X W G U L W E Y H B P U J O A G O  
M T J H Y M V G E C S U A D U J N S X R  
R O V B J E R S V T W S Z V Z N N I X M  
O S T A C P K O B Y N H Z U S T I N C W  
F N W H C A J E T M A I N T E N A N C E  
R M D H I T Q X M S V D V D P X H B U C  
E I D I N X O U W T E P W J B H Z Q O M  
P H G P E T N R R R D L I U B E R M O J  
U Q X J C I Z V G R Z S C L Z X J N E S  
L R B A C C W R G L A I R T S U D N I F  
Z G P I L P O S K N U P D X F Q B V Q O  
B M P E R U D M Z I Q U T G X Q J I G V  
I A A Z N J P H A O B Y Y S X D V P E C  
L N Z D S O R A M J E T V V M S B Y Y T

**CAN YOU FIND  
THESE HIDDEN  
WORDS?**

CATCHBASIN

CLEAN

IMPACT

INDUSTRIAL

INNOVATIVE

INTELLIGENT

INTUITIVE

MAINTENANCE

MUNICIPAL

PERFORMANCE

RAMJET

REBUILD

SAFETY

SEWER

STORMWATER

STREATOR

TRAINING

UNDERGROUND

VACTOR

WIRELESS



# STORMWATER MANAGEMENT

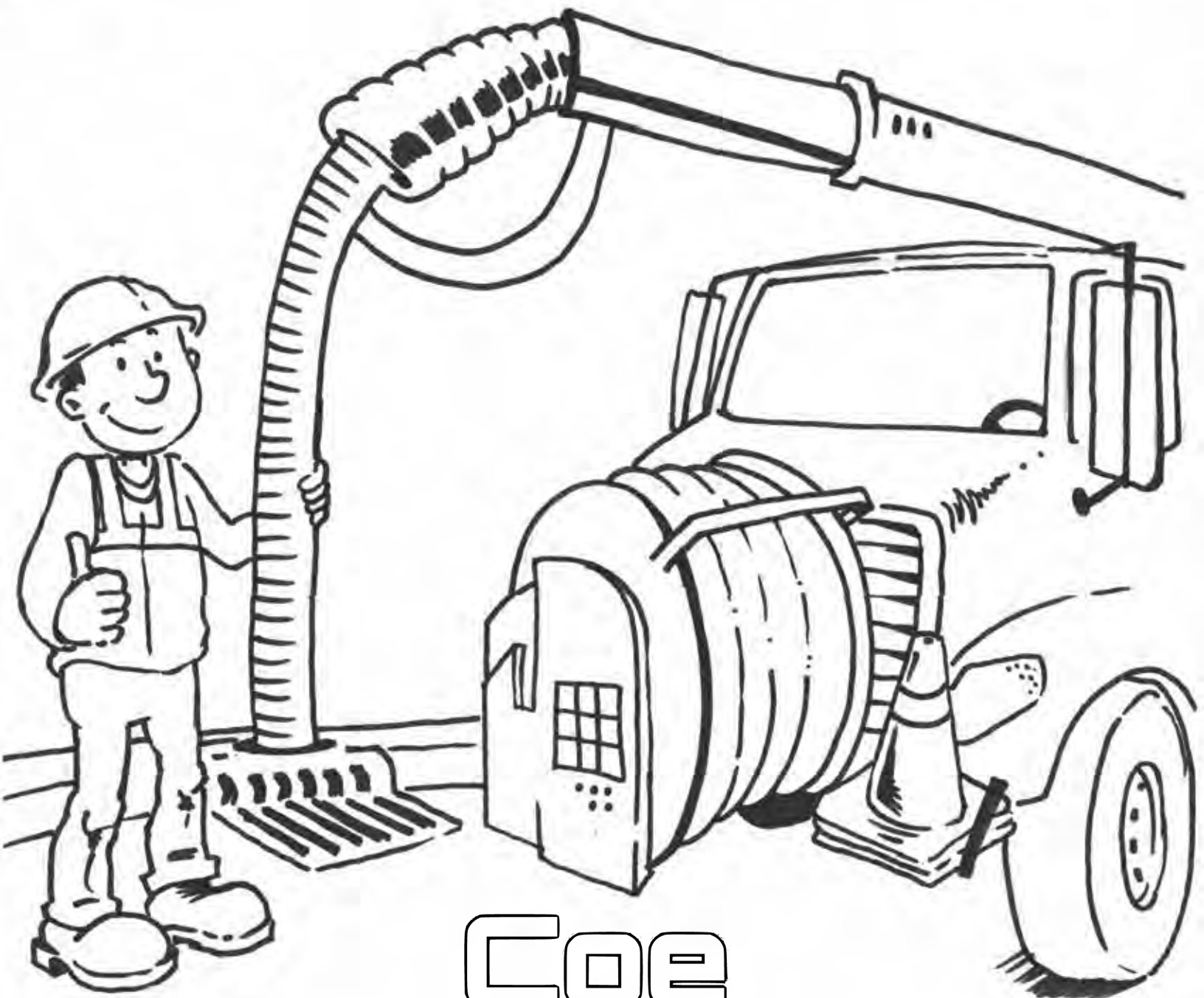

**COE**  
EQUIPMENT INC

# SUPPORTING INFRASTRUCTURE

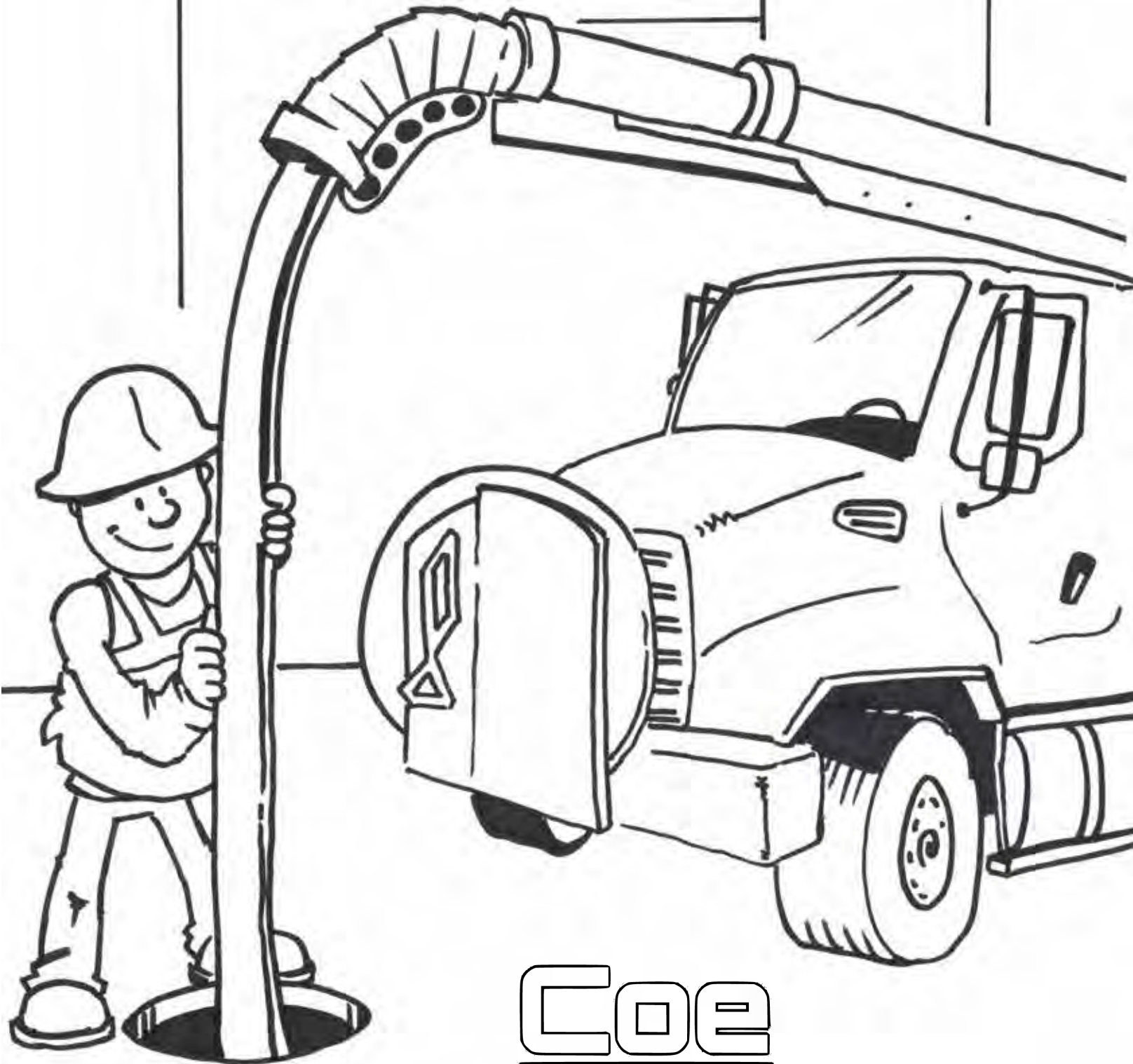

**COE**  
EQUIPMENT INC

# FIND THE WATER

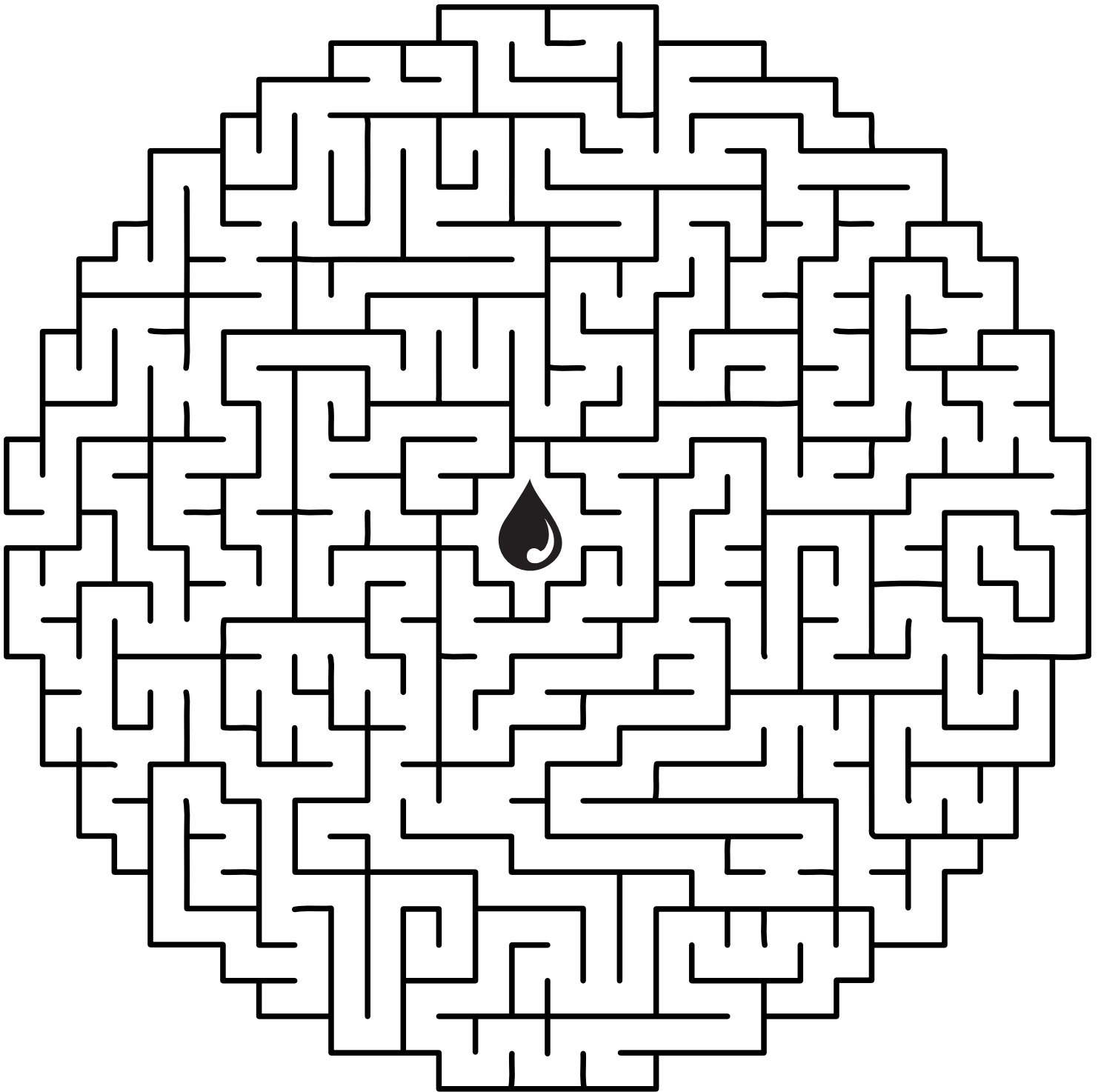



# BUILT BY SKILLED TRADES



**Coe**  
EQUIPMENT INC

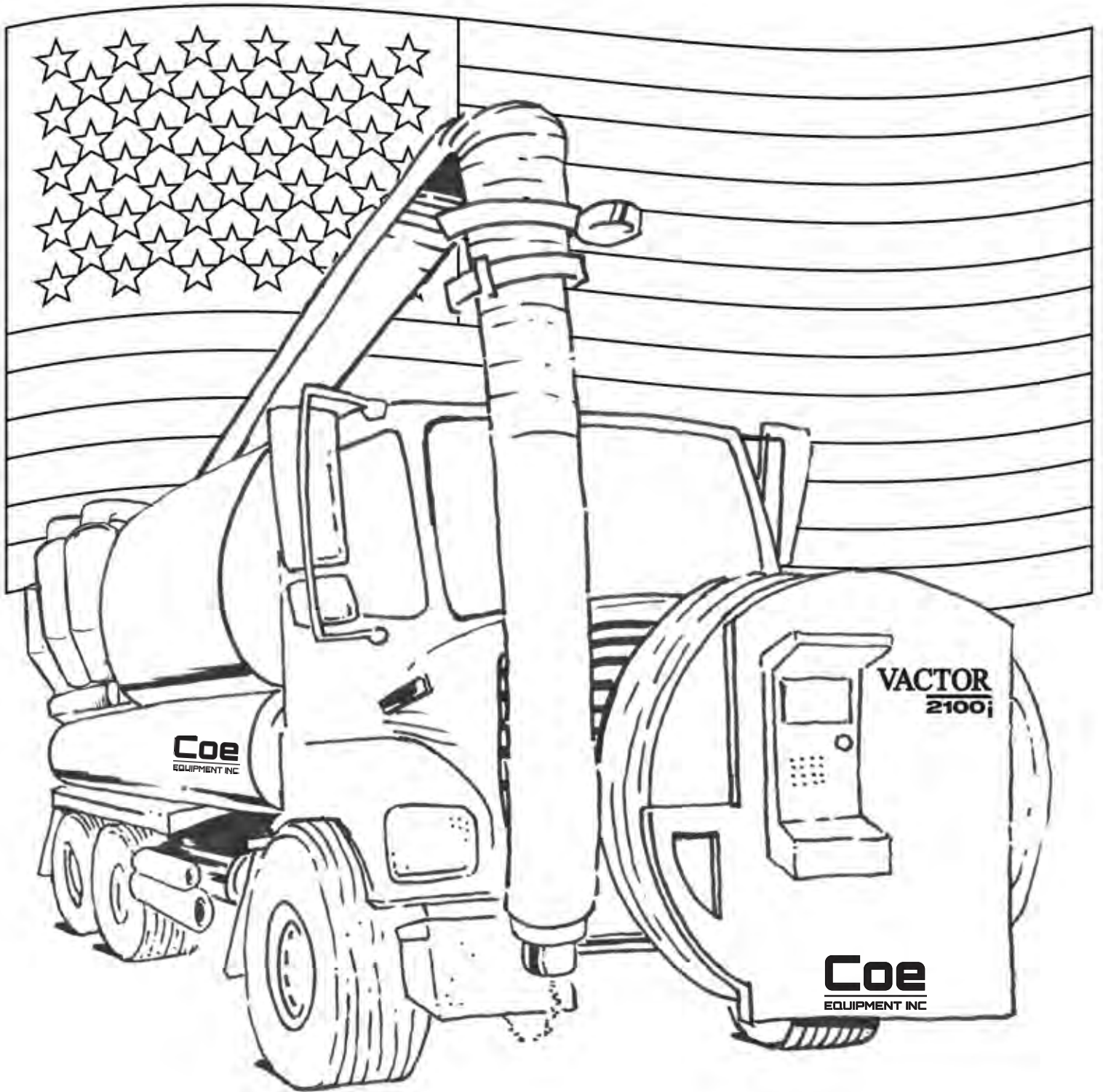

**PROUDLY  
MADE IN USA**

**Coe**  
EQUIPMENT INC

# SIMPLE ACTS... BIG IMPACT





# DOT GAME

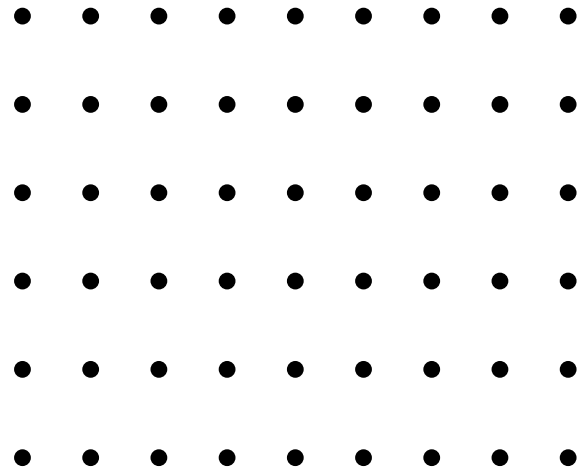
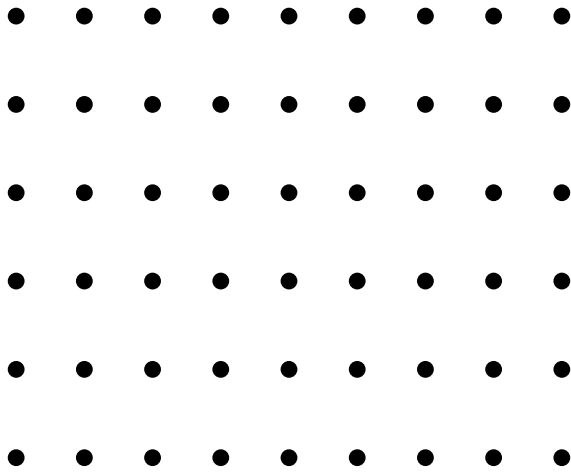
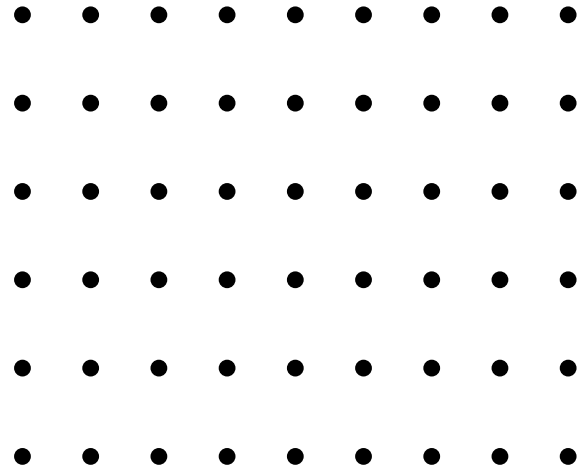
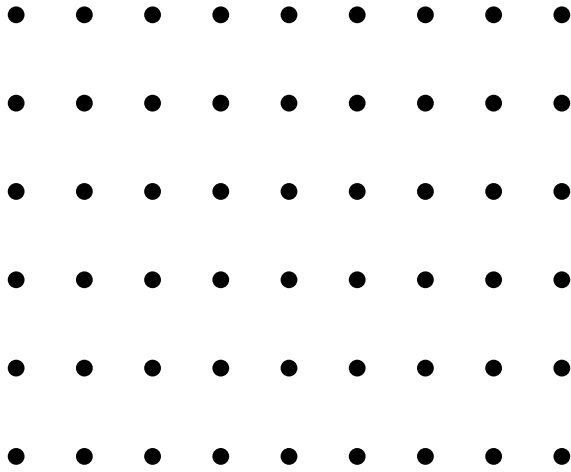

Each player take turns drawing one line. If that line completes a square, the player writes their initial in the box and draws another line. Play continues until all dots have been connected. The player with the most boxes wins.

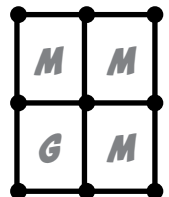



# TIC TAC TOE

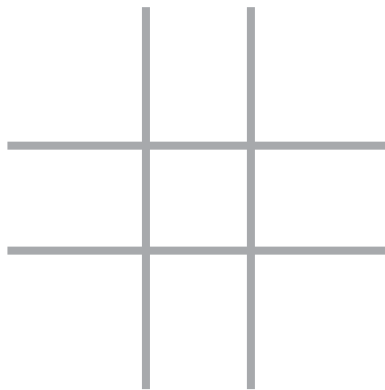
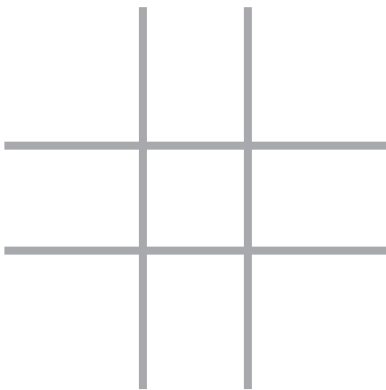
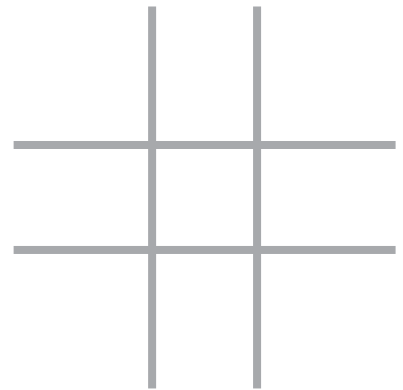
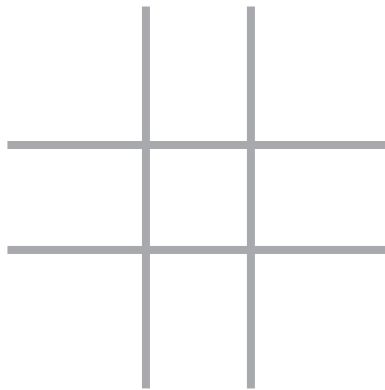
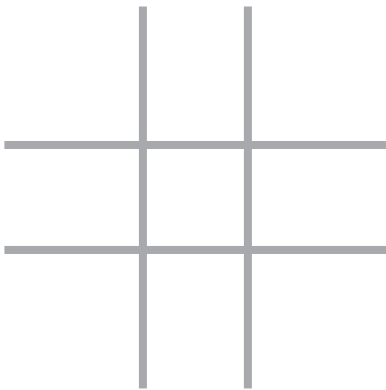
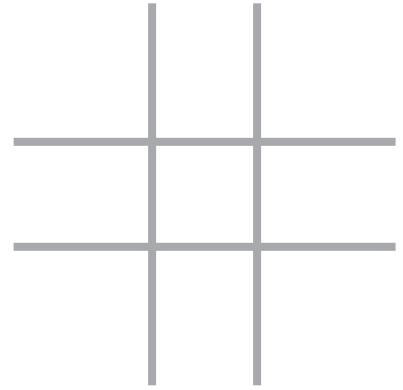
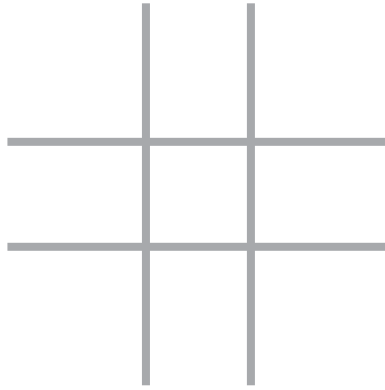
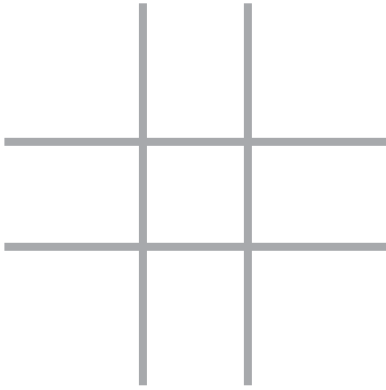



# VACTOR®



MUNICIPALITIES

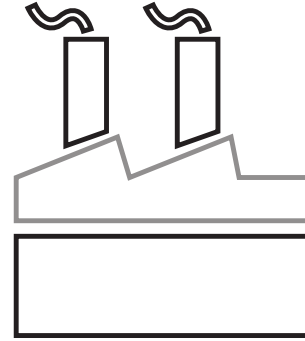

INDUSTRIES

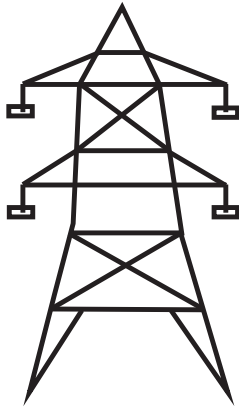

UTILITIES

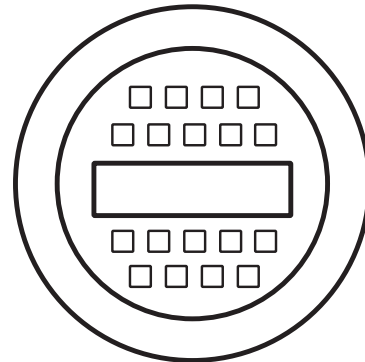

STORMWATER

**Coe**  

---

**EQUIPMENT INC**

5953 Cherry Street • Rochester, IL 62563  
Ph. (217) 498-7200 • Fax (217) 498-7205  
sales@coe-equipment.com  
www.coe-equipment.com